



# POLYWOOD

## Assembly Instructions



### Having Trouble?

If you have questions or concerns regarding assembly instructions or missing parts, please contact us at **(833) 665-6300** or email [support@polywoodoutdoor.com](mailto:support@polywoodoutdoor.com)



### Share your space

We love to see where our furniture ends up — snap a pic and share it on Instagram or Facebook!  
**#polywood**



### Watch & Learn

For assembly videos and more, visit [youtube.com/polywood](https://youtube.com/polywood)

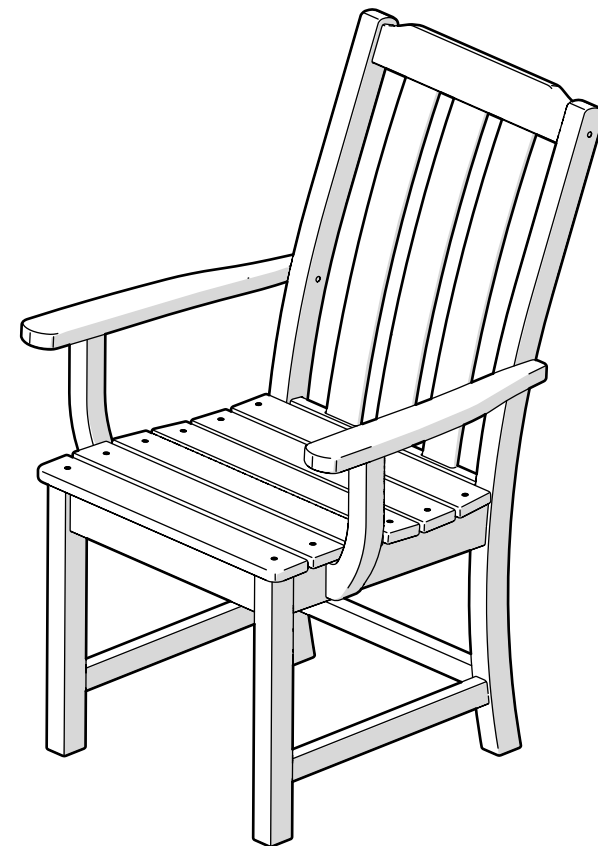

## TGD250 Heritage Dining Arm Chair

### 20-Year Warranty

To view our full warranty, please visit [polywoodoutdoor.com/warranty](https://polywoodoutdoor.com/warranty)

Easily register your product using one of the methods below:

#### Text POLYWOOD to 71403

Receive a link to register online

— or —

#### Register on our website

[register.polywoodoutdoor.com](https://register.polywoodoutdoor.com)

— or —

#### Send a Picture

Take a photo of the icon below and text it to 71403 (US only)

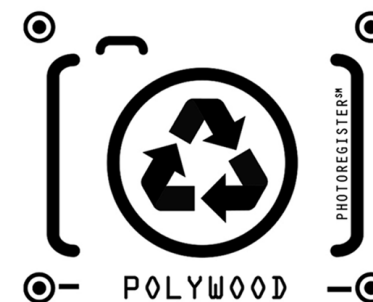

### Cleaning Tips

Even POLYWOOD gets dirty — here are some ways to help keep it clean:

#### For a quick clean:

Simply wipe down with soap and water.

#### For a deeper clean:

You'll need:

- » 1/3 bleach and 2/3 water solution
- » clean cloth
- » soft bristle brush

Wipe on solution with your cloth and let it sit on the lumber for a few minutes (this will not affect the color). Then, loosen any dirt and debris that may catch in surface grooves with a soft bristle brush; hose down to rinse.

# TOOLS

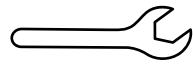

3/8" wrench  
(not included)

# PARTS

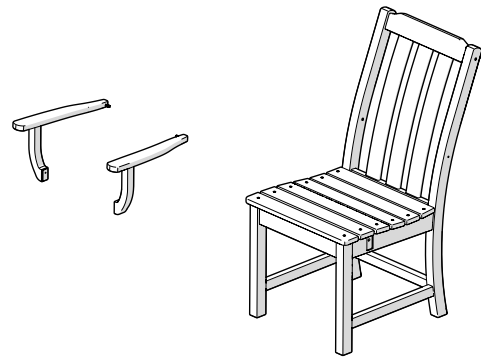

**A** x 2

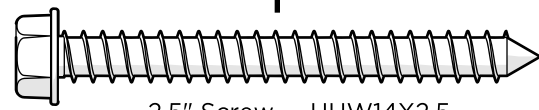

2.5" Screw — HHW14X2.5

**x 4**

Hole Plug — HSP.312x.25  
(Extra)

Something missing?  
Call (833) 665-6300

**1**

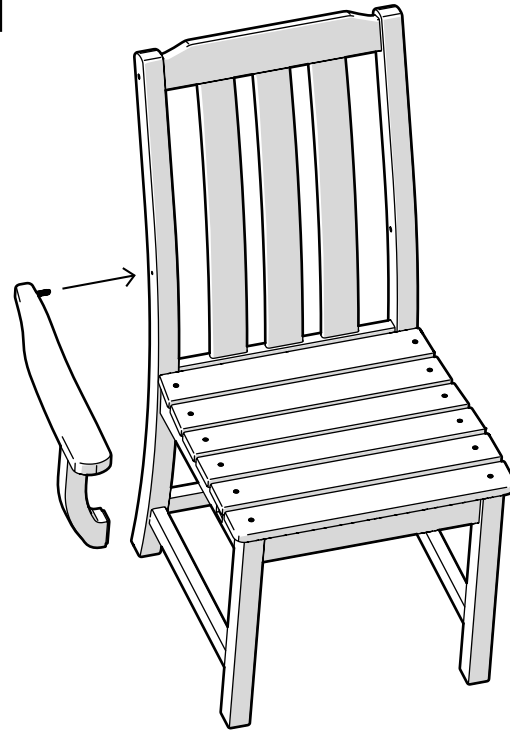

**2**

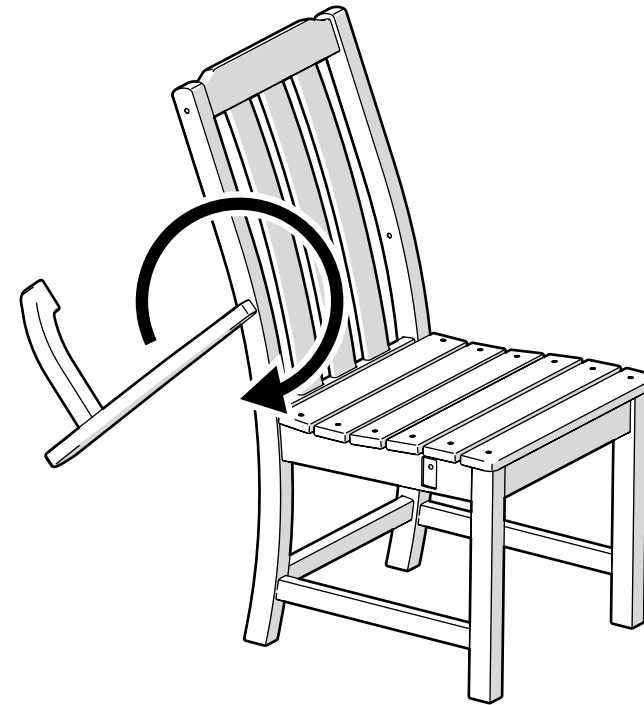

**3**

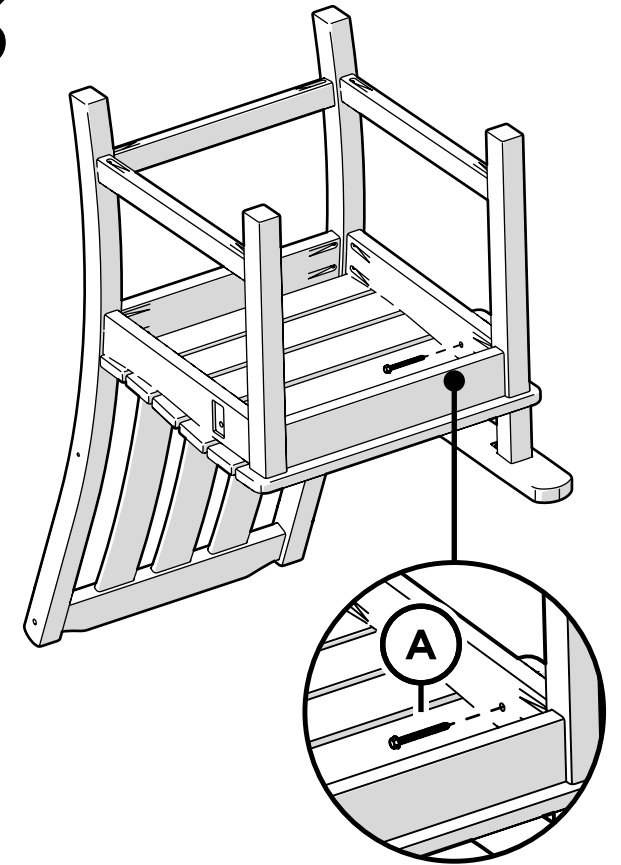

**4**

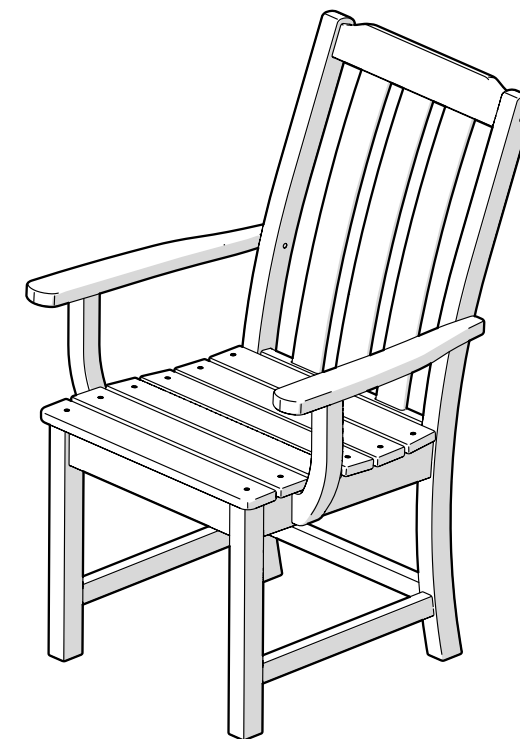
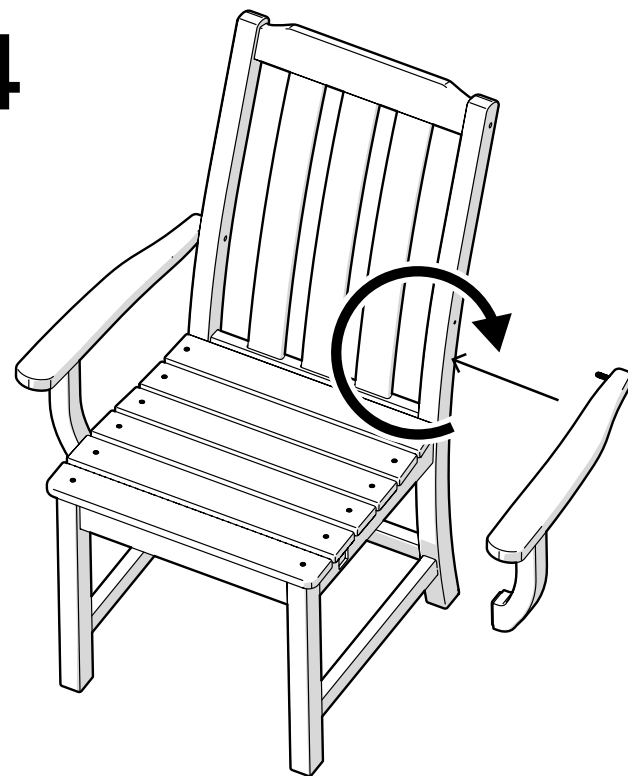

Repeat Steps 1 Thru 3  
On Opposite Side

**POLYWOOD**